

Kühlschienen

Extruded profiles / Profiles extrudes de refroidissement

KS 55.1

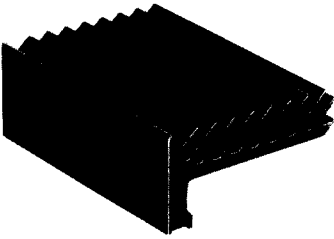

R_{th} K/W: ca. 3,6
 Material: AlMgSi 0,5
 Oberfläche: schwarz eloxiert
 Gewicht (g): 117
 Gehäuse: TOP 3/T0 220
 im Rastermaß 2.54

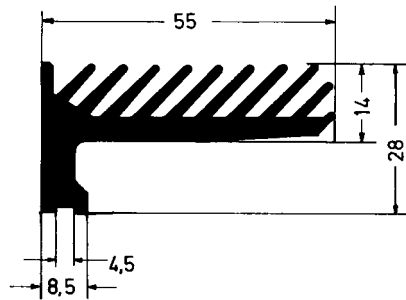

Bestell-Nr. KS 55.1-84 E 5 x M3

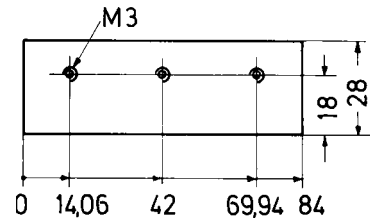
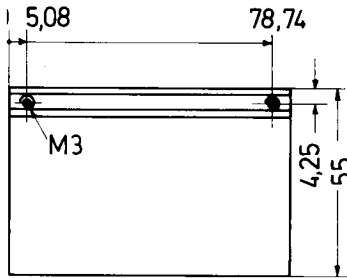
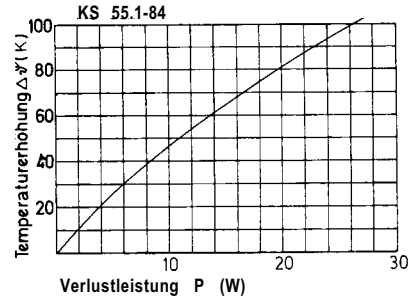

KS 55.1

Länge (mm): 25/37,5/50/75/100/150
 1000
 Gewicht (g/cm): 14

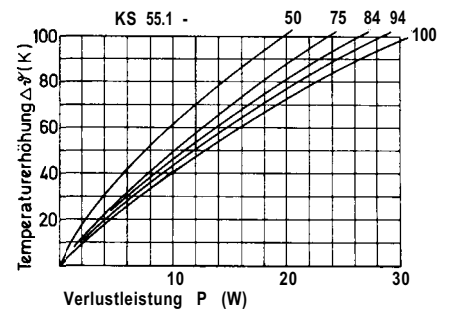
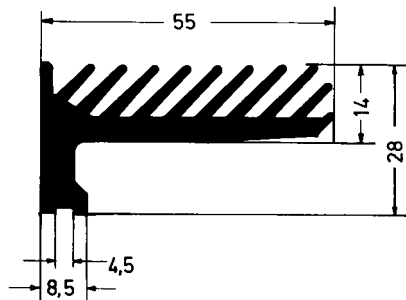

KS 57.2

Länge (mm): 25/37,5/50/75/100/150/
 1000
 Gewicht (g/cm): 13

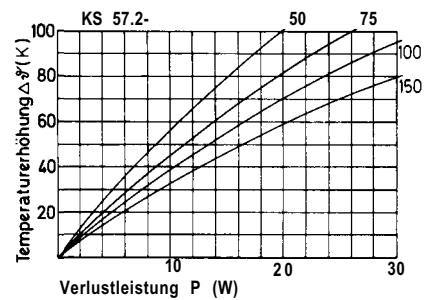
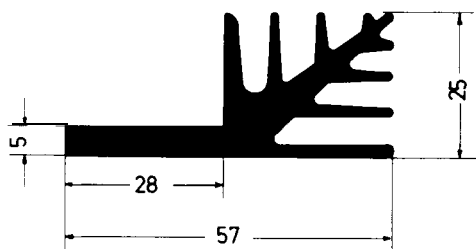

KS 63

Länge (mm): 25/37,5/50/75/100/150/
1000
Gewicht (g/cm): 21

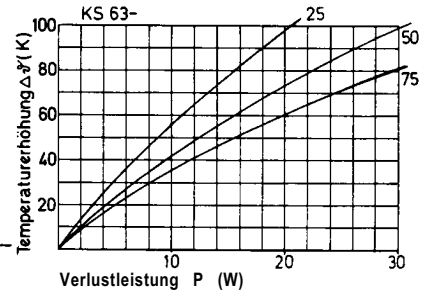
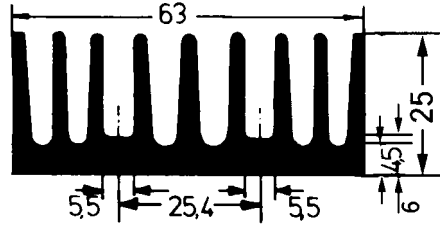

KS 65

Länge (mm): 25/37,5/50/75/100/150/
1000
Gewicht (g/cm): 11,1

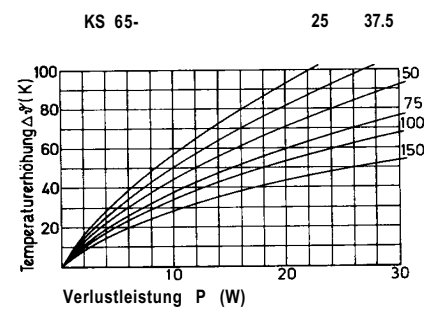
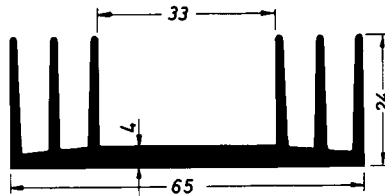

KS 65.4

Länge (mm): 25/37,5/50/75/100/150/
1000
Gewicht (g/cm): 12,3

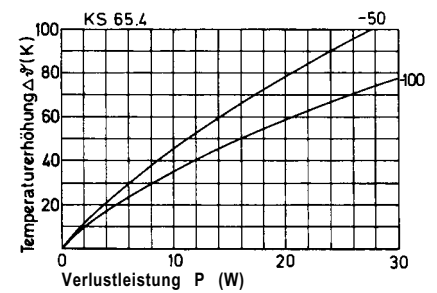
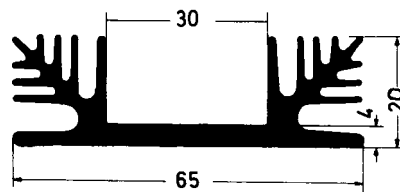

KS 70

Länge (mm): 25/37,5/50/75/100/150/
1000
Gewicht (g/cm): 7,6

